

SUGGESTED PRICE 50 CENTS

# THE WHYS OF THE WYES

THE BEHAVIOR OF  
TRANSFORMER  
Y CONNECTIONS

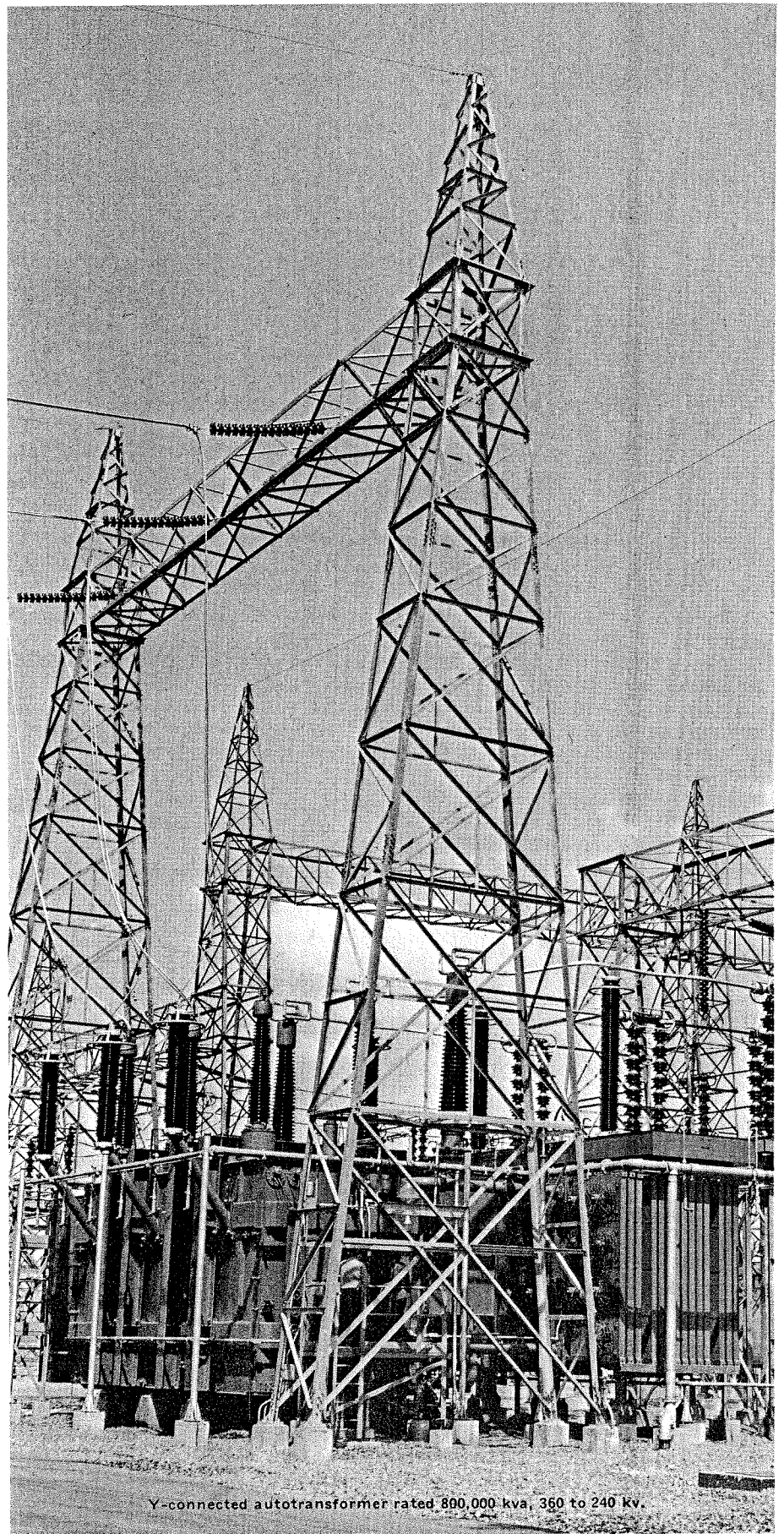

Y-connected autotransformer rated 800,000 kva, 360 to 240 kv.

GENERAL  ELECTRIC

# THE WHYS OF THE WYES

## PART I

### An introduction to the behavior of transformer Y connections

THE earliest transformers were of course single phase, connected directly across the two supply lines. With the advent of the three-phase system, two alternative methods of connection for transformers were offered—the delta fashion as the more obvious one based on the single-phase practice, and the Y fashion as an intriguing new possibility. Somebody must have been thrilled to discover that the Y connection works, and that if one wished to be different, he could even connect one side of the transformer in Y, the other in delta. The Y connection must have appealed to the operators then, as it does now, because (a) it provides two different values of secondary voltage instead of one, and (b) it makes it possible to ground all three phases symmetrically at a common point.

#### Problems of the Y-Y Connection

It didn't take the industry long to discover one problem after another arising out of the Y-Y connection with the primary neutral floating.

The first problem discovered was that in three-phase banks of single-phase units and in three-phase shell type units, although the line voltages conformed to turn ratio, the line-to-neutral voltages were not 58% of the line voltages but about 68% at no load and diminished very rapidly when the bank was progressively loaded line to neutral.

Oscillographic studies showed that with sine-wave voltages between lines, the line to neutral voltages of these banks had about 60% third harmonic component. This explained the overvoltage at no load, because, as the effective values of voltages at different frequencies combine at right angles,

$$\sqrt{58^2 + (.6 \times 58)^2} = 68.$$

The large voltage regulation of these banks for unbalanced line to neutral loads was discovered to be due to the fact that, whereas line-to-line loads cause a voltage regulation through the ordinary leakage impedance of the bank, the line-to-neutral loads caused a voltage regulation through their magnetizing reactance which is generally 100-1000 times as large as the leakage reactance.

The three-phase units with three-legged cores were found to behave quite differently in these matters. Their third harmonic voltages were negligible (according to the standards of those days), and the line to neutral voltages were practically 58%, and their voltage regulation for loads to the neutral, though poor, was not altogether intolerable.

In present-day language, a balanced three-phase line-to-line load causes voltage regulation through the positive phase sequence leakage impedance  $X_p$  of the bank; and a line to neutral load through a combination of the positive and zero sequence impedances of the bank, namely ( $\frac{2}{3}X_p + \frac{1}{3}X_o$ ). In three-phase banks of single-phase units and in shell-type three-phase units, the  $X_o$  is the same as the magnetizing impedance, and therefore such banks were altogether unsuitable for neutral loading. However, in small three-legged core type units,  $X_o$  was found to be of the order of 50%—100%, and such units could handle small high power factor line-to-neutral loads where the quality of the service (constancy of voltage) was not very high grade.

Around 1910 the industry thought that it understood the Y-Y connection well enough so as not to make a misapplication of it. An operator had a shell-type Y-

connected autotransformer on his ungrounded neutral system. He knew enough not to expect to load it to neutral, but one day he wanted to ground the neutral and could see no harm in it. That 68% leg voltage (instead of the proper 58%) could not hurt the insulation of the lines or bushings in any way. So he closed the neutral to ground. The lines flashed and the breakers opened to the amazement of the operator. The trouble was traced to series resonance between the third-harmonic magnetizing reactance of the transformer and the line capacitance to ground.

Although the third harmonic phenomena are more spectacular, yet Y connection has also important 60-cycle problems and also impulse problems which would be well for an operator to understand. So, we will discuss in easy stages such matters as these:

*In connection with the third harmonic*, why third harmonic problems and not other harmonics also; how to estimate the resonance condition; the effect of a secondary (or tertiary) delta winding; reactance and size of a tertiary delta winding; the three-legged three-phase core as the equivalent of a high reactance tertiary delta winding; residual third harmonic.

*In connection with 60-cycle problems*, we may discuss the various uses of the neutral; the requirements for satisfactory loading; the requirements for satisfactory grounding; inversion phenomena in autotransformers.

*In connection with transient phenomena*, impulse voltage behavior of windings; differences between Y and delta; the problems of the autotransformer, and so forth.

# PART II

## Third-harmonic characteristics of single-phase units

**W**HY so much fuss over the *third* harmonic in a transformer? Aren't there other harmonics in it too? The answer is, because we are interested in a *three*-phase system, In a five-phase system, the 5th harmonic would bother us; in an n-phase system, the n'th. It all comes about like this.

In a symmetrical n-phase star system with duplicate transformers (Fig. 1), excited sinusoidally and symmetrically, the magnetizing currents in the various phases will be alike in magnitude and distortion and displaced  $\theta$  ( $=360/n$ ) degrees apart. But in a symmetrical system, if the fundamentals of two adjacent phases are  $\theta$  degrees apart, their third-harmonic components must be  $3\theta$  degrees apart, the n'th harmonic components  $n\theta$  degrees apart, etc. These two considerations—that the wave shapes must be alike and that the harmonics will be displaced proportional to their order—are found to be perfectly consistent with each other. Applying these principles to the various harmonics of the three-phase system of Fig. 2, we find the following results. (The even-numbered harmonics are left out because normally they do not exist in the steady-state magnetizing currents, no matter how distorted these may be.)

**TABLE I**

PHASE ANGLES OF VARIOUS HARMONIC COMPONENTS IN A THREE-PHASE SYSTEM RECKONED FROM PHASE A

Harmonic	$\theta_A$	$\theta_B$	$\theta_C$	Phase Rotation
Fundamental	$0^\circ$	$120^\circ$	$240^\circ$	Positive
Third	$0^\circ$	$3 \times 120^\circ$ ( $=0^\circ$ )	$3 \times 240^\circ$ ( $=0^\circ$ )	Zero
Fifth	$0^\circ$	$5 \times 120^\circ$ ( $=-120^\circ$ )	$5 \times 240^\circ$ ( $=-240^\circ$ )	Negative
Seventh	$0^\circ$	$7 \times 120^\circ$ ( $=120^\circ$ )	$7 \times 240^\circ$ ( $=240^\circ$ )	Positive
Ninth	$0^\circ$	$9 \times 120^\circ$ ( $=0^\circ$ )	$9 \times 240^\circ$ ( $=0^\circ$ )	Zero
Eleventh	$0^\circ$	$11 \times 120^\circ$ ( $=-120^\circ$ )	$11 \times 240^\circ$ ( $=-240^\circ$ )	Negative
Thirteenth	$0^\circ$	$13 \times 120^\circ$ ( $=120^\circ$ )	$13 \times 240^\circ$ ( $=240^\circ$ )	Positive
Fifteenth	$0^\circ$	$15 \times 120^\circ$ ( $=0^\circ$ )	$15 \times 240^\circ$ ( $=0^\circ$ )	Zero

Some of the harmonics are seen to be three-phase, with a phase rotation or "sequence" like the fundamental (positive) and some negative; and some are single-phase, identical in all three phases. Thus,

1st, 7th, 13th are 3-phase with positive rotation

5th, 11th, 17th are 3-phase with negative rotation

3rd, 9th, 15th are 1-phase with no-phase rotation

Hence the adjective "zero-sequence" for the third harmonic and its multiples.

Those harmonic components of the three line currents which have the same frequency, and which are balanced and three-phase, flow freely in the lines, regardless of the condition of the neutral lead, because they add up to zero there. But those harmonic currents which are in-phase with each other in all three lines, like the third-harmonic components, cannot act as return to each other, and must return through the neutral; and if the neutral is open as in Fig. 2, they cannot flow at all in the lines. They are suppressed. The line currents of Fig. 2 therefore cannot have any third-harmonic components.

The suppression of a current may be represented by the superposition on it of an equal and opposite current. This superposed current, acting like a magnetizing current, will naturally produce and superpose on the circuit a voltage at its own frequency. Thus it happens that the suppression of the third-harmonic current in a circuit like Fig. 2, consisting of single-phase units or a three-phase shell-type unit, produces large third-harmonic voltages. The magnitude of the suppressed third harmonic currents is about a half of that of the fundamental currents, and the resulting third-harmonic voltages are about the same fraction (60% — 65%) of the fundamental voltage.

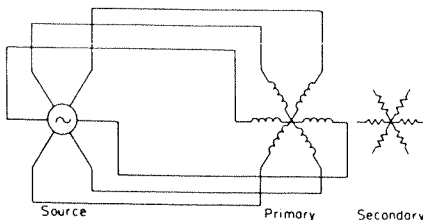

**FIGURE 1. Symmetrical n-phase star system with duplicate transformers**

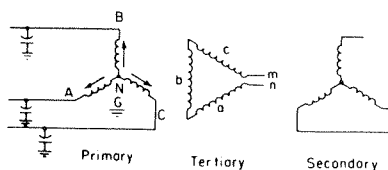

**FIGURE 2. Three-phase system**

With the help of the foregoing understanding, we now can draw a number of inferences regarding the system of Fig. 2.

1. The third-harmonic voltages induced in the primary coils A, B, C will be induced also in the tertiary coils, a, b, c; and because the latter are in series, the voltage  $E_{m-n}$ , across the open corner m-n, will be the sum of the three coil voltages. As the fundamental voltages cancel at m-n,  $E_{m-n}$  will be a pure third and equal to  $3 \times 65\%$ . If we wanted a pure third-harmonic voltage for some application, this would be a pretty good source of supply for it, though one of very high internal reactance and therefore of poor voltage regulation.
2. In Fig. 2 the third-harmonic voltages will appear in the line-to-neutral voltages A to N, B to N, and C to N, but not in the line-to-line voltages, A to B, B to C, and C to B, because in these latter cases the third-harmonic voltages of the two included phases oppose and cancel each other.
3. In general the third-harmonic voltage will appear also from N to ground. This is based on the reasonable assumption that when we try to measure  $E_{NG}$  by connecting a voltmeter between N and G, there will be enough capacitance to ground from the lines A, B and C to complete the circuit of the voltmeter current. We may also add that, whereas  $E_{AN}$  contains a fundamental and a third,  $E_{NG}$  will consist entirely of third-harmonic voltage, assuming that the system is perfectly symmetrical.

4. There will be practically no third-harmonic in the line-to-ground voltages  $E_{AG}$ ,  $E_{BG}$ ,  $E_{CG}$ .

5. If we should ground the neutral of the transformers (Fig. 3), leaving the neutral of the source of supply isolated,  $E_{NG}$  disappears completely, and  $E_{AG}$ ,  $E_{BG}$  and  $E_{CG}$  now exhibit the full third-harmonic voltages induced in the coils. This can be dangerous, for each phase will be equivalent to a circuit like that of Fig. 4, a third-harmonic voltage  $E_3$  exciting a magnetizing impedance  $X_L$  in series with a capacitance reactance  $X_C$ . If  $X_L$  and  $X_C$  should be of the same order of value, there will be a resonance build-up of voltage. The fact that  $X_L$  is non-linear prevents the

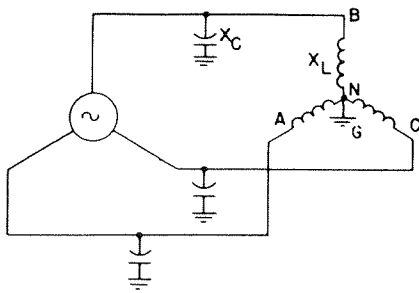

FIGURE 3. Transformer neutral grounded

resonance from building up infinite voltages but not from building up troublesome ones.

When the 60-cycle charging current of the line is of the order of one-third of the 60-cycle magnetizing current of the transformer, the values of  $X_L$  and  $X_C$  will be alike for the third harmonic, and this condition is not at all unusual. Large departures from resonance can still produce substantial harmonic intensification. Let  $X_C$  be twice as large as necessary for resonance: then the

line-to-ground third-harmonic voltages (across  $X_C$ ) will be twice  $E_3$ , and thus equal to about 130% of the fundamental.

- If in Fig. 2 the open corner m-n of the tertiary delta be closed, the induced third-harmonic voltage becomes short-circuited, and disappears from the primary and the secondary windings as well, except for a minute value due to the leakage reactance between the windings. This short-circuiting does not produce any large currents in the delta but just the normal third-harmonic exciting current of the units. Y-primary delta-secondary transformers, at no load, exhibit a pure third-harmonic exciting current circulating in the delta, equal to about one half of the exciting current in the primary.\*

If the delta winding had no other function or duty than to circulate the third-harmonic current, its kva rating

\* Ampere values must of course be corrected for the turn ratio; but when currents are expressed as percentages of the full load current of the respective windings, no correction is needed for turn ratio.

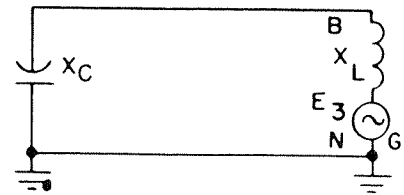

FIGURE 4. Circuit equivalent of each phase

would not be more than a few percent of that of the transformer, but as we shall see later, ordinarily it is subjected to other duties also, which necessitate a 30-50 per cent kva capacity in the tertiary.

The leakage reactance of a tertiary delta winding with respect to the other windings can be very high and it will still reduce the residual third-harmonic voltage to a negligible value so far as quality of service and the safety of the windings and the connected apparatus are concerned; but telephone interference sets a more rigid limit to residual harmonic voltages, demanding lower reactance tertiaries, and then single-phase short-circuit currents demand greater current capacity in them.

## PART III

### Singular properties of the core-type three-phase transformer unit

THE core-type three-phase unit, on a three-legged core, has some singular characteristics, both 60-cycle and third-harmonic, compared with a three-phase bank of single-phase units or the shell-type three-phase unit. At the bottom of these singular characteristics lies the fact that the three-legged three-phase unit, without a delta winding, behaves as if it had a concealed fictitious delta winding. Actually the tank acts as a loosely coupled equivalent delta winding. As a result of that, this type of a Y-Y transformer exhibits 2% or less third-harmonic voltage as against 60%-65% for the Y-Y bank of single-phase units. There are some important 60-cycle consequences also of this equivalent delta winding. The physical principle which this equivalent delta incorporates or explains is stated more concisely in somewhat more sophisticated language by saying that *the three-legged three-phase core construction reduces drastically the zero-phase-sequence magnetizing impedance of a Y-Y bank.*

#### Characteristics of the Zero-phase-sequence Current

As hinted before, a current that is identical in all three lines—that is, of the same magnitude and phase in each line—is called a *zero-phase-sequence current* (Fig. 1). Such a current has to return through the neutral, making the neutral current three times that in each phase. As the normal balanced three-phase currents, whether positive or negative, do not flow in the neutral, *we can identify a zero-phase-sequence current in magnitude and*

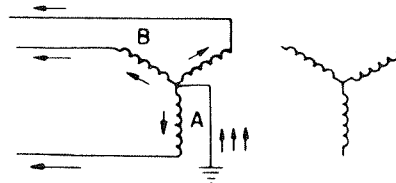

FIGURE 1. Schematic diagram of the zero-phase-sequence current in a Y-Y winding

*phase (and even wave shape) as one-third of the neutral current.*

Although the third-harmonic component of the exciting current is of this type, yet it may be clear from the definition that a zero-phase-sequence quantity need not be limited to a particular frequency. In another installment of this article we shall deal with 60-cycle zero-phase sequence currents, which is another reason for belaboring the reader with this matter which may sound academic but which actually developed out of practical engineering design work.

Fig. 2 illustrates the zero-phase-sequence currents and fluxes of a bank of single-phase units. The solid arrows are currents, the dotted ones fluxes. The currents are assumed to flow only in the Y-connected primaries A, B, C; none in the secondary or tertiary windings (which therefore are not shown). The currents will be seen to act as magnetizing currents on the cores with the same effectiveness as in normal operation.

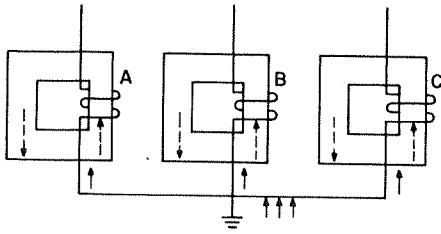

FIGURE 2. A bank of single-phase units showing zero-phase-sequence currents and fluxes

1. Although the fluxes in the three cores are in phase with each other, instead of the normal  $120^\circ$  angle between them, the three phases do not affect each other or modify the reactance offered by any one of the windings. Therefore, for the same current values, the impedance offered to these currents is the normal magnetizing impedance of the transformer.

2. As the magnetizing impedance of a winding is the reciprocal of the magnetizing current at unit (or 100%) voltage, for a transformer with .5% to 5% magnetizing current the corresponding impedance will be 20,000% to 2000%. These values will of course be lower under saturation.

For comparison with the foregoing, let us consider now the three-phase core-type unit, on a three-legged core, illustrated in Fig. 3. Here the dotted arrows (the fluxes) may be seen to be flowing into a magnetic "blind alley." When they reach the yoke, they will find the magnetic highway to have ended at a wall, and they will have to jump off into the air to return to the bottom yoke to close their circuit. Whereas in Fig. 2 the flux path was entirely in iron, and the winding reactance was accordingly high, in Fig. 3 the introduction of a big air gap into the path of the third-harmonic flux drastically reduces the reactance of the windings for these

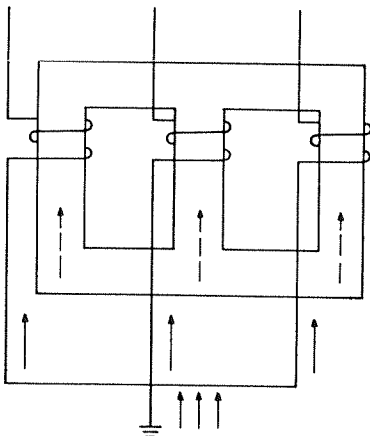

FIGURE 3. Current and flux flow in three-phase core-type unit, three-legged core

currents from the previously noted values (2000% to 20,000%) down to 50%-200%.

When the third harmonic current is suppressed, the resulting voltage is directly proportional to the zero-phase-sequence impedance of the winding and hence, in the 3-legged core designs, with no conventional delta winding, the third harmonic voltage may be only a few percent compared with 60-65 percent for a bank of single-phase units having several thousand percent zero-phase-sequence impedance.

If the foregoing has been of interest, the reader may wish to look into these matters somewhat more quantitatively. We shall consider first the harmonic currents circulating in both the conventional and the equivalent deltas; and then the resulting residual third-harmonic voltages.

### Harmonic Currents in the Deltas

Suppose we have two banks of identical Y-delta windings, one set on single-phase cores, the other on a three-legged three-phase core. Assuming the normal leakage reactance of the windings as 10%, the bank of single-phase units will exhibit 10% zero-sequence reactance at 60 cycles, 30% at triple frequency; and the core-type three-phase unit will exhibit the resultant of the reactances of two delta windings in parallel, one conventional and having 10% reactance, and the other equivalent and having (say) 50% reactance, with a resultant value of 8.3% at 60 cycles, 25% at triple frequency. The current in the conventional delta of the three-phase core-type unit will be 83% of that in the delta of the single-phase units, the deficiency (17%) representing the circulating current in the equivalent delta, or, what amounts to the same thing, the zero-sequence magnetizing current of the core-type transformer.

The foregoing points to the conclusion that, when an actual delta winding is provided, there is not a great deal of difference between the three-legged three-phase unit and the bank of single-phase units so far as the zero-sequence circulating currents in their respective deltas are concerned. In the case of third-harmonic phenomena, this approximate equality of circulating currents is in marked contrast to the big difference in the voltages in the absence of the deltas.

### Residual Third-harmonic Voltages

Let us see if we can calculate the residual voltages under various conditions.

Fig. 5 shows one phase of a bank and crystallizes the problem. Let coil 2 be connected in delta and circulate the third harmonic current. We wish to know the third-harmonic voltage  $E_1$  across coil 1

and connected in Y. In this figure we find third-harmonic magnetomotive forces in three places; the magnetomotive force drops,  $F_a$  in portion *a* of the core, and  $F_b$  in portion *b* of the core; and the magnetomotive force  $F_2$  in coil 2 which is circulating the third harmonic m.m.f.  $F_2$  will equal approximately the negative of the counter magnetomotive forces, that is— $(F_a + F_b)$ . The total m.m.f. drop along the closed path (*a* + *c*) will then equal  $(F_2 - F_a)$ , which equals  $-F_b$ . The triple frequency flux in the leakage space *c* will then be equal to  $F_b$  times the permeance of region *c*. This latter is given directly by the leakage reactance of the transformer, %  $IX_{12}$ . For the resulting voltage, this is to be multiplied by 3 for triple frequency.

$$\% E_3 = \frac{3 \times \% IX_{12} \times \% F_b}{100}$$

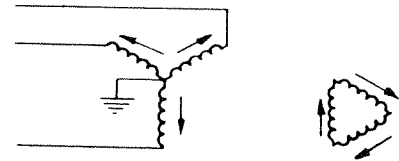

FIGURE 4. Grounded neutral Y-delta winding

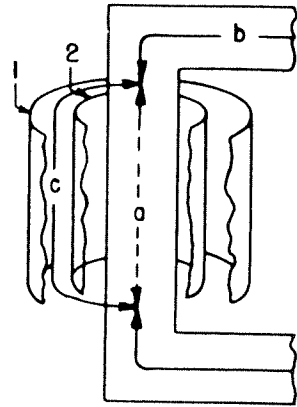

FIGURE 5. Schematic view of one phase of bank. Coil two is to be connected in delta

Let us tabulate a few typical cases. We assume that the third harmonic current is one-half of the total, and that  $F_b$  is one-third of that of the total core.

a. We note that, in a Y-delta transformer, with the leakage reactance up to 10% and the magnetizing current up to 5%, the residual third-harmonic voltage in the Y is brought down below a quarter of one percent.

b. Considering the bottom two items (50% and 200% reactance, representing Y-Y connected 3-legged 3-phase units with equivalent high-reactance deltas), the residual third-harmonic voltage in the Y is seen to be less than

Leakage Reactance Y to Delta % IX <sub>12</sub>	Third Harmonic Voltage in % of Fundamental		
	When Mag. I = 1% and F <sub>b</sub> = 0.17%	When Mag. I = 2% and F <sub>b</sub> = 0.33%	When Mag. I = 5% and F <sub>b</sub> = 0.8%
5%	E <sub>3</sub> = 0.025%	E <sub>3</sub> = 0.05%	E <sub>3</sub> = 0.12%
10%	0.05%	0.1%	0.24%
50%	0.25%	0.5%	1.2%
200%	1.00%	2.0%	4.8%

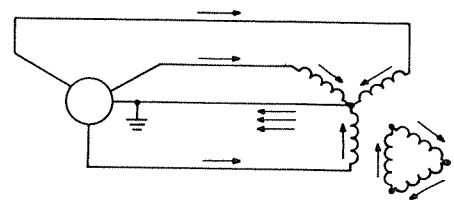

FIGURE 6. Neutral grounded core-type three-phase Y-Y unit showing current paths

5% and generally less than 2%, in contrast with the corresponding Y-Y banks of *single-phase* units exhibiting 60%-65% third-harmonic voltage.

Let us consider now two proposals: (a) to add an actual delta to the 3-legged core-type unit; and (b) without the addition of a delta, to ground the neutral of the Y on a grounded system.

a. When an actual delta is added, this delta will in effect be in parallel with the equivalent tank delta, and to a first approximation the two deltas will divide the circulating third-harmonic current inversely as their reactances. Accordingly, in a Y-delta transformer on a 3-legged core having 10% normal reactance and an equivalent tank delta of 50% reactance, the real delta will carry  $50/(50+10) = 83\%$  of the total

third, harmonic ampere-turns, and the equivalent tank delta the rest.\*

Although in any case the circulating third-harmonic currents are too small to be worth calculating so far as the safety of the windings is concerned, they are important in case (b).

b. If the neutral of a core-type three-phase Y-Y unit is grounded on a solidly grounded system (Fig. 6), the third-harmonic current has two parallel paths in which to flow: one is the equivalent delta, the other the lines and neutral of the system. If now we assume that the zero-phase-sequence impedance of the supply system is 10% based on the rated kva of the transformer, and the equivalent delta reactance as

\* This assumes for simplicity that the reactances belong to the deltas.

low as 50%, then  $50/(50+10) = 83\%$  of the third-harmonic current of the transformer will flow in the lines and ground. In the case of the bank of Y-Y single phase units, the ground current would have been 100% of the third-harmonic current of the transformer, instead of 83%.

The reduction in the third-harmonic ground current accomplished by the Y-Y core-type unit is very small compared with the reduction in the third-harmonic voltage.

In an ungrounded system, the neutral of a Y-Y *core-type* three-phase unit could be grounded with perfect impunity from third-harmonic voltage troubles; but in a grounded system, about the same third-harmonic ground currents may be expected from the three-phase core-type unit as from a bank of single-phase units (of any type), both banks in Y-Y connection.

## PART IV

### Various sixty-cycle characteristics of Y transformer connections

IN THE preceding installments, four Y's were considered without formal listing as such, namely, isolated Y-Y, grounded Y-Y, isolated Y-delta, and grounded Y-delta. There are more complicated Y's also, like the zig-zags, and we shall have a few words about them, too. The 60-cycle characteristics of these connections to be considered here are the voltage stresses under line disturbances, the short-circuit currents under line faults, and the voltage regulation under unbalanced loads to neutral.

#### Y-Y Connection, Isolated Neutral

The terminal characteristics of all transformer connections with isolated neutral are alike, and no external tests

can distinguish between the Y and the delta or the other operative connections. The inability of this connection to supply unbalanced line to neutral loads has already been pointed out in Part I. So this case need be considered here no further.

#### Y-Y Bank with Grounded Neutral

##### 1. Supply System Isolated

Looking at Figure 1 it can be seen at a glance that, because the neutral is electrically tied down to ground, its potential can never rise or sink, and therefore it would be possible to grade the insulation of the windings from zero (or a nominal value) at N to full insulation test value at A, B, C. This about exhausts possible favorable comments on this case.

As to the limitation of this system of operation, the following may be noted:

(a). The third harmonic hazards of this connection have already been pointed out in Part II, and need not be repeated here.

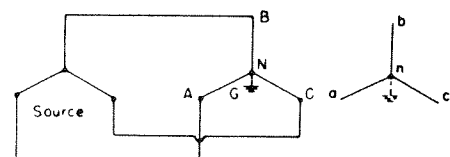

FIGURE 1. Y-Y with supply system isolated



(b). A little-known peculiarity of this connection is possible neutral *inversion*, that is, the neutral may go outside of the triangle of the line voltages, as illustrated in Figure 2. Figure 2a recognizes that

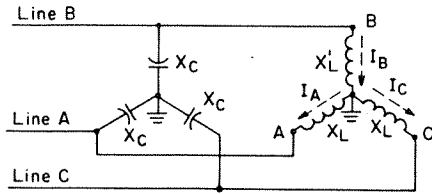

FIGURE 2A. Inductance bank connected in parallel with capacitance bank, phase by phase

the setup represents an inductance bank in parallel with a capacitance bank, phase by phase. Let all  $X_C$ s be alike, but one of the inductances ( $X'_L$ ) be different from the other two ( $X_L, X_L$ ) for a reason soon to be explained. Let  $X_L$  be smaller in ohms than  $X_C$ , and  $X'_L$  greater than  $X_C$ . Then the net currents of phases A and C will be lagging, as the two  $X'_L$ s draw more current than their mates  $X_C$ ; while the net current of phase B will be leading. The normal position of the neutral can not satisfy this condition. To see this clearly, consider the single-phase circuit of Figure 2b:

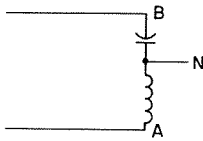

FIGURE 2B. Single-phase circuit

the potential of point N can not be between those of A and B, but has to be either above A or below B—the neutral N will be thrown out. Similarly, the neutral of Figure 2a will go outside of the triangle of the line voltages, as shown by the solid lines in Figure 2c. The dotted lines are the standard conditions for comparison. Now the current in line B can return through lines A and C in parallel. This might be seen more easily with the help of the arrows. The dotted arrows in Figure 2a are positive directions thought to be simpler for the present purpose, and the solid arrows in Figure 2c are the vectors consistent with the assumed positive directions. The reader may choose his own arrowheads as he pleases, but those for Figure 2c must be consistent with those for Figure 2a.

I hope the reader feels that he is not interested in academic possibilities, that the three inductances should have been assumed duplicates, because I feel that

way myself and, therefore, I assume the three transformers are duplicates with the further recognition that their reactances will vary with the voltage. Actually I had in mind transformers that drew, at their normal voltage, a fraction of the charging current of the line; but under overexcitation, more than the charging current of the line. Such a system could stay in balance with the neutral in its normal place, but is likely to be unstable; if any little transient condition should shift the neutral, it may keep going until it comes to balance as in Figure 2c and stick there.

The requirement for this phenomenon, that at normal voltage the transformers should draw less magnetizing current than the charging current of the lines,

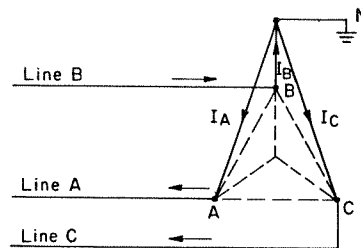

FIGURE 2C. Neutral outside voltage triangle

indicates that this trouble is more likely to be experienced with grounded Y-Y potential transformer banks on moderate voltage short isolated systems. That has been the experience, but the dangerous proportions can also happen with distribution or even power transformers. If these have not been experienced, it must be because a grounded Y-Y power transformer bank on an isolated system must be a very rare thing.

(c). On such a system, a line fault on one phase, such as at B (Figure 3a), shorts the 60-cycle voltage of that phase, —B to N; and the voltage diagram of the windings changes from the solid lines of Figure 3a to the dotted lines, shown more clearly in Figure 3b in solid lines, where we see that the unfaulted legs take over the line voltages in open-delta fashion, representing 73% overexcitation. The secondary (a, b, c) also is in open delta, with full-line voltages across windings that were formerly the legs of the Y.

Such overexcitation may draw an exciting current several times as large as the full-load current. It would be unfortunate indeed if the breakers were on the secondary side (a, b, c), with only disconnecting switches at A, B, C, in which case the primary windings could get roasted out, as this exciting current, even though very large, may not trip the breakers at the source. To protect

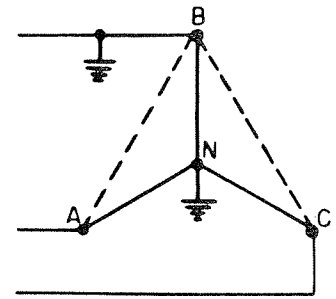

FIGURE 3A. Dotted lines show changes caused by fault on phase B

such a bank, it would be necessary to use differential relays arranged to short-circuit the primary lines in case of trouble, so as to force the supply station breakers to trip. But if we are reconciled to tripping those breakers, the more appropriate transformer connection would be the grounded Y-delta or Y-Y delta because, in addition to the benefit of graded insulation, we can also secure freedom from the 173% voltage stress we have noted.

If, in Figure 3a, A-B-C is a core-type three-phase unit, it will behave like a high-reactance Y-delta transformer and draw a larger fault current than a bank of single-phase units would do. While the latter draws only a (large) magnetizing current, the former would draw in addition a small short-circuited current.

(d). The neutral of the secondary (n, Figure 1) may be either isolated or grounded. If it is isolated, no particular problems are presented other than those of any isolated system. If the neutral is grounded, then a ground on the lines a, b, c will have the same effect as a ground on the lines A, B, C, shorting out that phase of the bank and bringing about the same condition of overexcitation of the remaining phases as shown in Figure 3b. If the primary impressed voltage is maintained, the secondary output voltage also will be maintained across the lines, even though the overexcited transformers may be roasting.

If the secondary neutral is grounded, the purpose might be to operate a four-wire system. Then an unbalanced circuit in the neutral will shift the neutral through the zero-sequence impedance drop of the bank. Such a current can have any phase angle whatever, depending not only on the power factor of the load, but also on the phase or combination of phases from which it is being supplied. The worst situation is when  $I_0$  is at right angles to one of the phase voltages, the leading current being as objectionable as the lagging. Figure 4 shows  $I_0$  as lagging  $90^\circ$  behind  $E_{an}$ . The result-

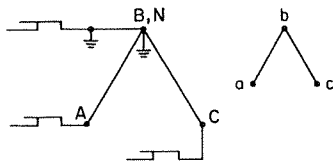

FIGURE 3B. Solid lines show unfaulted legs taking over line voltage in open-delta fashion

ing reactive voltage drop will be parallel to  $E_{an}$  and will subtract from it arithmetically,  $n$  moving to  $n'$ , so that the new phase voltages under such a load will be  $E_{an}'$ ,  $E_{bn}'$ ,  $E_{cn}'$ , the change in  $E_{an}$  being the worst. Let us estimate its magnitude.

As an upper figure for the neutral current, it is logical to assume that the neutral current entering the bank is equal to the rated line current of the bank, and

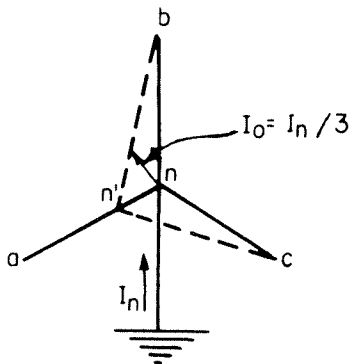

FIGURE 4. Unbalanced circuit showing  $I_0$  lagging 90 degrees behind voltage  $E_{an}$

then  $I_0$  ( $=I_n/3$ ) will be 33%. As for the value of the zero-sequence impedance, in a bank of single-phase units (or shell-type three-phase units), the minimum zero-sequence impedance may be taken as 1000% (ignoring saturation), in which case the neutral shift will be 333%. That is, the bank can not deliver such a load, as this exceeds the line-to-neutral short-circuit current of the bank. Even though the resulting overexcitation and saturation will greatly increase the current, it may be clear enough that this is not a permissible operation.

In the case of the core-type three-phase unit, we may assume  $Z_0$  as 50%, in which case the neutral shift will be 16.6%. If  $I_0$  is lagging as shown in Figure 3,  $E_{an}$  will drop 16.6%; and if  $I_0$  is leading,  $E_{an}$  will be boosted 16.6%. Both cases are intolerable. However, if the neutral current does not exceed 25% of the line current, the voltage regulation will be 4.1%, which then might be defended as tolerable as an occasional

happening. I believe this has been tried more than once on a very small scale and gotten by in some cases, abandoned in others.

## 2. Both System and Y-Y Transformers Grounded

Considering Figure 5, we note that each phase of the transformer bank is directly associated with a corresponding phase of the source, and such operation should be foolproof. Well, it is—almost. Such a system is free from voltage rises due to neutral shift under line-to-ground faults; and the secondary can handle a four-wire distribution system with normal voltage regulation. However, both neutrals must be carried along on fourth wires along with the line wires, as otherwise both third-harmonic and 60-cycle currents will flow in the ground, with possible telephone interference and other troubles. The advantages of this connection can be obtained and its disadvantages avoided more or less by the Y-delta and the Y-Y delta connections, which we shall consider now.

### Y-Delta

In a Y-delta bank, whether the Y is primary or secondary, the grounding of the neutral of the Y permits the grading of the transformer insulation and also tends to stabilize the 60-cycle potentials of its terminals (Figure 6a), but its efficacy for the latter purpose depends on several considerations.

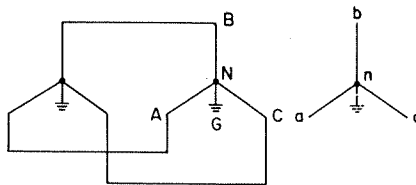

FIGURE 5. System and transformers grounded

When the source is effectively grounded, a line fault eliminates one phase voltage regardless of the connections of the step-down bank, and the voltage diagram becomes as shown in Figure 6b: something between A-B-C and A'-B'-C', depending on how closely the different phases are coupled at the source.

If the Y is primary, with its neutral grounded, and the source is isolated, and if the source impedance is negligible compared with the transformer impedance, then in case of a line-to-ground

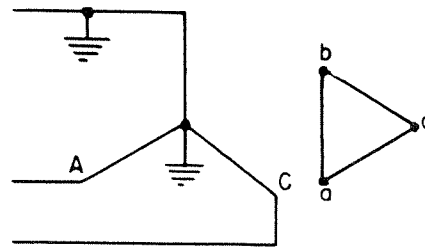

FIGURE 6A. Y-delta bank, Y neutral grounded

fault, the primary voltages are maintained and a voltage diagram like that of Figure 3b results. This points up the fact that an isolated system can not be effectively grounded by grounding the neutral of a small Y-delta bank capable of drawing only a small short-circuit current in case of a line-to-ground fault.

If the source impedance is not negligible, then the voltage diagram will be intermediate between A'-B'-C' and A-B-C (Figure 6c), the former representing the most effectively grounded system, the latter a poorly grounded (or isolated system).

We may well ask, how dangerous is A-B-C (Figure 6c)? How necessary is it to insist on approaching the A'-B'-C' perfection?

The sixty-cycle overvoltages, amounting at the most to 173% of normal, are generally well within the insulation strength of the transformers, as all units receive a high-potential test of  $3.46 \times$  the leg voltage + 1000 volts. The voltage stresses are not critical, but the following conditions at least must be satisfied. The fault current must be capable of burning off minor faults, and in case of their persistence, to trip the breakers at the source. The kva rating of a grounding bank answering this requirement will be a substantial fraction of the source kva.

It may also be seen that where the sixty-cycle overvoltages are dependably low, the lightning arresters can be selected for a correspondingly lower voltage, thus affording better lightning protection. In practice the arrester rating can not be lowered down to 58% for two reasons. First, the short circuiting of one phase to ground may increase the voltages across the other phases to ground.

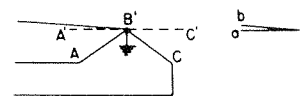

FIGURE 6B. Changes in diagram 6A caused by line fault eliminating one phase voltage



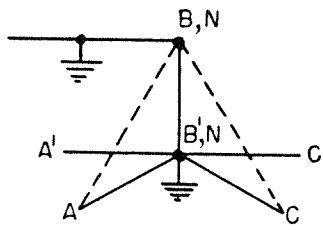

FIGURE 6C. Changes in 6A caused by line fault when source impedance is not negligible

Of course this will not be anything like that in Y-Y connection, but still it may be substantial as dynamic voltage for the lightning arresters. Second, when breakers open a large load, the supply voltage may rise considerably until voltage regulators can bring it back, and this also needs to be taken into account in the choice of lightning arresters. It appears that the appropriate lightning arrester levels for grounded systems vary generally from 65% to 80% of the rated line-to-line voltage. If the primary is delta, and the secondary grounded Y, the Y secondary can furnish a four-wire distribution system with not much more than normal voltage regulation. Whether or not the primary system and winding are grounded is immaterial; but economies are possible by grounding these. This leads us to the Y-delta-Y connection.

### Y-Delta-Y Banks

The advantages of the Y-delta-Y connection (Figure 7) are well-known: both Y's can be grounded and graded; either Y can handle loads to neutral with normal regulation; the primary and secondary voltages are in phase with each other (in contrast to Y-delta); third harmonic voltages are so small that very refined measurements would be needed to detect them at all; the delta can be used for a tertiary load at its own voltage; and the reactance of the delta can

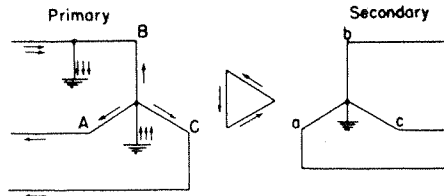

FIGURE 7A. Y-delta-Y connection showing a line-to-ground fault on primary line B

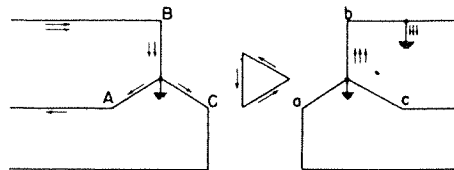

FIGURE 7B. The Y-delta-Y connection showing a fault on the secondary line b

be adjusted to be different from those of the Y's, so that the bank will offer a desired reactance to line-to-ground faults, and another desired reactance to loads and three-phase short circuits.

It is customary to make the kva rating of the delta winding 35%-50% of the primary. This is dictated by the short-circuit duty imposed on the tertiary winding. Figure 7a illustrates a line-to-ground fault on the primary line B. The currents are drawn on the conservative assumption that the source is either isolated or so far away that all of the fault current in the ground flows into the transformer neutral. We see here that the short-circuit ampere turns in the delta are equal to those in the primary, and if the short-circuit current must be large enough to trip the line breakers after the set time delay, no 5 or 10 percent delta will do.

Figure 7b illustrates a fault on the secondary line b. The duty on the delta now is one third of the maximum in the secondary, and one half of the maximum in the primary. Unless the delta is to be the secondary or a major winding like it, an excellent compromise is effected by making the effective reactance of the bank for line-to-ground fault twice that of the major windings to three-phase shorts, and providing the delta with 50% capacity. This makes possible a rugged tertiary winding.

## PART V

### The Y with the ground-fault neutralizer

IN THE early days, isolated systems were more common than the grounded ones on the theory that the isolated system would provide better continuity of service, because a single line-to-ground fault would not trip the breakers as it does in a solidly grounded system. Experience, however, showed that frequently one line fault was followed by another or a failure, and the breakers did trip after all. In the grounded system, the breakers would have tripped without the second fault or the apparatus failure,

and saved the failure. One explanation of this peculiar behavior of the isolated system is that a line fault on such a system constitutes an unsteady arcing ground, with a capacitance discharge current oscillating at the natural frequency of the circuit, and *by restrikes could build up four to five times the normal voltage on the lines.\** Such per-

\* Experimental evidence for this in the case of switching surges is available, but comparable data are not available in the case of arcing grounds. See the A.I.E.E. Committee report in the Transactions for 1948, pp. 912-921, especially conclusions 1, 2, 6, and 12.

sistent oscillations could obviously result in damage to the connected apparatus. This (and other considerations) led to wide acceptance of grounded-neutral operation. Meanwhile, invention took a hand in this situation. Professor Petersen of Germany reasoned that, if the arcing-ground current can be rendered non-oscillating, this kind of a voltage build-up will be avoided, and then isolated system operation becomes practical. His solution of the problem took the following simple form.

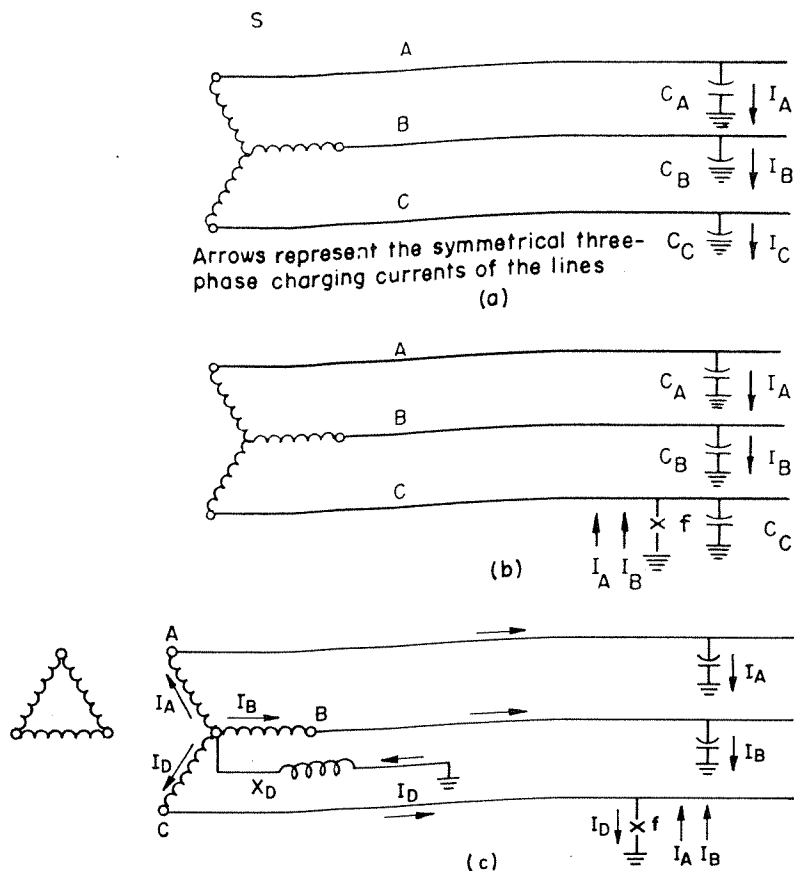

FIGURE 1. Isolated system showing application of ground-fault neutralizer

### One Solution

Figure 1a illustrates the capacitance charging currents of a normal system. The capacitance current of each line to ground returns through the capacitances of the other two lines, without requiring any current in the neutral, as for any symmetrical three-phase load.

In Figure 1b, line C has become grounded through a fault  $f$ . This removes the voltage across its capacitance  $C_C$ . No current will now flow through  $C_C$  for lack of voltage across it, but currents can flow through  $f$ , and we note that  $I_A$  and  $I_B$  now return through this fault. These currents are in quadrature with the voltage producing them. Therefore, when the currents are zero, the voltages are maximum, and any tendency to make the arc go out as the currents are passing through zero brings on a large recovery voltage and possible restriking, giving rise to an oscillation between the series inductance and shunt capacitance of the lines.

The leading currents  $I_A$  and  $I_B$  could be neutralized at the fault by an inductive current appropriately introduced into the circuit as shown in Figure 1c. Here,  $X_D$  is an inductance connected be-

tween neutral and ground, and its lagging current ( $I_D$ ) returns through  $f$ . If it is of the right magnitude (that is,  $I_D = -I_A - I_B$ ), it can neutralize  $I_A$  and  $I_B$  at  $f$ . The arrow for  $I_D$  is shown opposite to those of  $I_A$  and  $I_B$ , because lagging and leading currents are naturally opposite. The only current that can not be neutralized at  $f$  is the power component of the currents. But this component is generally very small; and, what is more important, when a power component of current is passing through zero, so is its voltage passing through zero, and the arc can go out without bringing on a substantial recovery voltage to cause a recurrent oscillation. This reactor ( $X_D$ ) is appropriately called a ground-fault neutralizer.

The maximum voltages to ground are practically limited to 1.73 times normal. As the charging current and kva of the lines are generally small, the current and kva of the reactor to neutralize them are also correspondingly small, so that the cost of the equipment can not be prohibitive.

Neutralization requires that  $X_D$  be adjusted (tuned) to the capacitance of the

system, and, therefore, a ground-fault neutralizer is built adjustable.

As this method of operation involves connection between the neutral and ground, it becomes necessary to see to it that a third-harmonic voltage does not get impressed on the ground-fault neutralizer. For such a voltage,  $X_D$  would be in series with the capacitances of the unfaulted lines and would thus invite third-harmonic series-resonance troubles. So far as the 60-cycle voltages are concerned,  $X_D$  is, in effect, in parallel with the capacitances, and any resonance is parallel resonance, which is utilized to rob the current from the arc. It is for this reason that Figure 1c shows a delta winding on the supply transformer bank.

### Selecting a System

It is not the thought of this writer to advocate this particular system of operation as against grounded-neutral operation. For a preference, an operator will naturally weigh many considerations, which may be different in different cases. A few considerations, generally applicable, might be noted here. (a) For the same system voltage, an effectively grounded system permits use of a lower lightning arrester voltage level than the isolated system equipped with a ground-fault neutralizer. Thus, system protection can be improved, system insulation can be reduced, or some of each benefit obtained. (b) When the neutral is solidly and permanently grounded, the major insulation of the neutral end of the transformers can be reduced. (c) If the breakers of a grounded system are set for an appreciable time delay, some of the faults may burn themselves out, without causing shutdown. If the breakers are set for a short time delay, they may open, putting out the arc, and then immediately reclose, giving only a momentary interruption quite often acceptable with the concepts of good service. So a line-to-ground fault does not necessarily mean a long duration line outage.

#### Selected Bibliography

1. An authoritative report on the subject of system overvoltages is that of the A.I.E.E. General Systems Subcommittee entitled "Power System Overvoltages Produced by Faults and Switching Operations," in the 1948 *Trans. A.I.E.E.*, pp. 912-922. See particularly the conclusions. A bibliography of 83 references also will be found there.

2. Clarke, Cray and Peterson, "Overvoltages During Power System Faults," *Trans. A.I.E.E.*, 1939, pp. 377-385.

3. Evans, Monteith and Witzke, "Power System Transients Caused by Switching and Faults," *Trans. A.I.E.E.*, 1939, pp. 386-396.

4. On theory and application to lightning arresters, see

4. Peterson and Hunter, "System Overvoltages and Lightning Arrester Application," publication GER-393 (copies available from the General Electric Co. free on request), reprinted from *Electric Light and Power Magazine*, November, 1941.

# PART VI

## The analysis of unsymmetrical banks.

THE variety of possible unsymmetrical banks are a legion. As the more important cases have already been covered in various publications available to the reader,\* we propose here, in the spirit of our title, to explain how such cases are analyzed.

### Y-Y with Unequal Units, Isolated Neutral (Figure 1)

If the exciting currents of the three units are not alike because of differences in size or other reasons, the neutral potential will not be central to the three terminals. This does not affect the load (line) voltages, but it does affect the core losses of the units. The smaller units will take up more of the voltage, and the neutral will move towards the line terminal of the largest unit, or of the unit having the largest exciting current at the same voltage.

The coil currents will be identical with the respective line currents, regardless of the sizes and reactances of the units. So the maximum permissible symmetrical three-phase load will be limited to three times the kva rating of the smallest unit.

If the three-phase load is small, and a large single-phase load has also to be furnished, say across phase A-B (Figure 1), it can be done satisfactorily by seeing to it that C is rated at least one-third of the three-phase kva, and A and B is each rated at least one-third of the three-phase kva, plus 57.7% of the single-phase load kva. If the single-phase load is a lighting load (with unity power factor), and the three-phase load is a power load with 86.6% power factor, then in unit B the two component currents will be in phase with each other (dotted arrows), calling for their arithmetic addition in B. The multiplier, 57.7%, comes from two facts: first, only half of the single-phase kva is furnished by B, suggesting the factor 0.50 for B's share of the single-phase kva. But as the single-phase kva load is not at twice the voltage of B but at only 1.73 times that of B, the half-load current will be 15.5% more than what it would have been at the voltage of B. So we have the factor 57.7% instead of 50% for the single-phase load component.

If the single-phase load is three-wire, as it generally is, this isolated Y-Y bank is not adapted to it. A mid-tapped auto-transformer, connected across lines A and B, would be needed to secure the neutral for a three-wire single-phase system. Two other alternatives would be as follows.

If all the neutrals (including that of the primary source) were grounded, and a fourth wire provided on each side for the neutral currents, three-wire single-phase loads, such as at 120/208 volts, could be furnished. Then each phase would be independent of the others, and the size of each transformer would be determined by the load connected to that phase of the circuit.

The other alternative would be a Y-delta connection, described in the following section.

### Y-Delta with Isolated Neutral (Figure 2)

Figure 2 shows an isolated Y-delta system, with the mid-point of one of the delta windings brought out and grounded to furnish 120/240 volt service on that phase. Considering the distribution of three-phase loads in such a bank, we can start with the recognition that a symmetrical three-phase load on the secondary lines will produce substantially

symmetrical three-phase currents on the primary lines; and, as the primary side is in Y, coil and line currents will be alike. Thus, the three-phase load will be divided substantially equally, as in Y-Y, regardless of the sizes and reactances of the three transformers. Considering the single-phase load, let us assume units A and B are of equal size, and unit C is larger. Whatever current flows in the secondary C will have its counterpart in the primary C, and this in its turn will have to return half through A and half through B. That is, the load in A or B will be one half of that in C regardless of their kva ratings and reactances. Then, depending on the relative power factors of the two loads, the load on unit C will be as high as  $\frac{1}{2}$  of the three-phase kva plus  $\frac{2}{3}$  of the single-phase kva; and the load on A or B will be as high as  $\frac{1}{3}$  of the three-phase kva plus  $\frac{1}{3}$  of the single-phase kva. To make this more concrete, assume a 15-kva three-phase load, and a 45-kva single-phase load. One might have wished (and believed) that this could be handled by a bank in which A=5 kva, B=5 kva, and C=5+45=50 kva. But according to the foregoing analysis, to be suitable for any combination of power factors, A and B will have to be 5+15=20 kva each; and C, 5+30=35 kva.

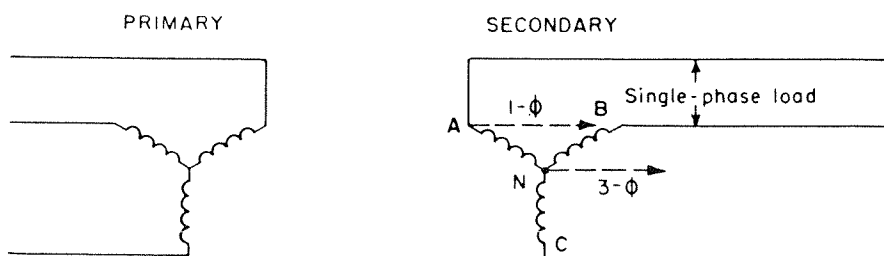

FIGURE 1. Y-Y connection with unequal units and isolated neutral

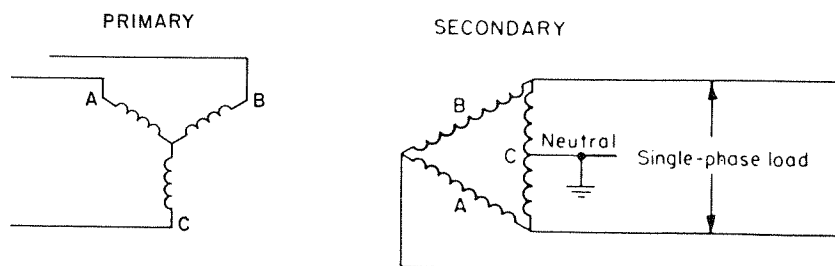

FIGURE 2. Y-delta connection with isolated neutral

\* See Blume, L. S. and Boyajian, A., "Transformer Connections," publication GET-2.

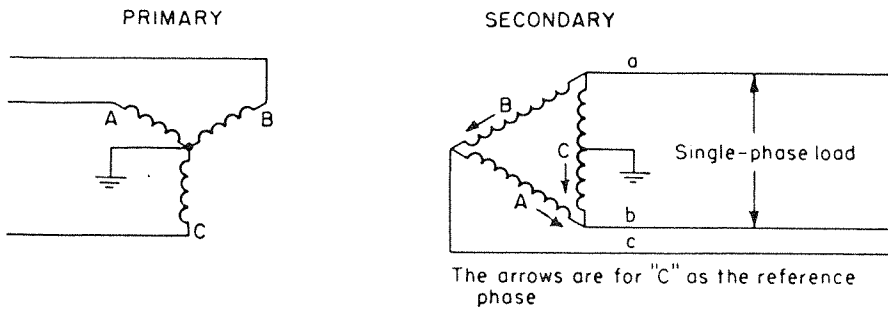

FIGURE 3. Grounded Y-delta bank on a grounded system

### Grounded Y-Delta Bank on a Grounded System (Figure 3)

If the neutral of the source supplying the Y is isolated, grounding the neutral of the Y would have no effect on the distribution of the load. But if both neutrals are grounded, then it may be seen that for the single-phase load indicated in Figure 3, unit C is in parallel with A and B in series, and the division of this load between these two parallel paths will vary inversely according to their leakage impedances. Similar comments apply to the loads on the other phases. For the last example, a 15-kva three-phase load and a 45-kva one-phase load, let us see how two 5-kva units (at A and B) and one 50-kva unit (at C) would work out, assuming all units have the same percent reactance at their respective rated loads. Reducing the reactances to a common base, say 50 kva, the reactances will be in the following proportions:

TABLE 1

Units	Reactance
C (50 kva)	1
A (5 kva)	10
B (5 kva)	10
A and B in series	20
A and C in series	11
B and C in series	11
A+B+C	21

To simplify the example, let unity power factor be assumed for both the single-phase and the three-phase loads. The three-phase load may be thought of as in delta, which makes it easier to see that the (45+5) kva load across the lines a—b will add up to 50 kva; and of this, 20/21 fraction (=47.5 kva) will be fed by C. The rest of the current, representing 2.5 kva, will flow in A and B in series, loading up each one to 2.5 kva.

The 5-kva load across b—c will load A up to (11/21) 5 = 2.6 kva, and B and C each to 2.4 kva; and somewhat similar comments obviously apply to the load across the lines a—c.

Tabulating these component kva loads, together with their relative phase angles, we obtain the results shown in Table 2. It is seen that the bank is perfectly adapted to the combination load.

Comparing this with the previous case, it will be seen that if the Y neutral is now disconnected, the smaller units will burn out.

Different power factors would, of course, modify the above load distribution, increasing it in some places, and reducing it elsewhere.

Combining the various component currents or kva's properly (vectorially) in such cases is a painful matter, and even the experienced has to be wary. The scheme used above regarded each line-to-line load as a single-phase load, and

the voltage of that phase as the reference vector for that transformer. From this point of view, the other two phases are  $\pm 60^\circ$  (instead of  $120^\circ$  or  $240^\circ$ ) from the reference phase; their projection to the reference phase is ( $\pm 0.5$ ) times in both cases, and the three items in the last column add arithmetically. The arrow heads in Figure 3 represent the calculation for unit C, and give expression to the thought that  $E_B + E_A = E_C$ . They don't apply to A or B as the reference phase. The arrows appropriate to unit A as reference, are shown in Figure 4A, expressing the thought that  $E_B + E_C = E_A$ , and the arrows appropriate to B as reference are shown in Figure 4B, expressing the thought that  $E_A + E_C = E_B$ .

It is not our thought here to urge this point of view. Those who like to work with three-phase vectors need not change or apologize. In checking the foregoing results by that method, one will have to be sure whether to add or to subtract each component.

### Open Y-Open Delta (Figure 5)

When the three-phase load is small and the single-phase one relatively large, the connection shown in Figure 5—open Y primary and open delta secondary—is sometimes considered. If the neutral of the source is also grounded, this is an operative connection, and has the ad-

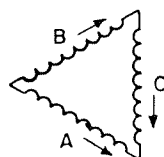

Arrows appropriate for "A" as the single-phase reference phase  
 $E_B + E_C = E_A$

FIGURE 4A. Current flow with A as the single-phase reference phase

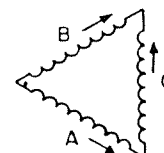

Arrows appropriate for "B" as the single-phase reference phase  
 $E_A + E_C = E_B$

FIGURE 4B. Current flow with B as the single-phase reference phase

TABLE 2

	From a-b	From b-c	From a-c	Resultant
Unit C	47.5 kva in-phase with C	2.4 kva +60° from phase C	2.4 kva -60° from phase C	47.5 + 1.2 + 1.2 = 50 kva.
Unit A	2.5 kva -60° from phase A	2.6 kva in-phase with phase A	2.4 kva +60° from phase A	1.25 + 2.6 + 1.2 = 5 kva.
Unit B	2.5 kva +60° from phase B	2.4 kva -60° from phase B	2.6 kva in-phase with phase B	1.25 + 1.2 + 2.6 = 5 kva.

vantages of few units and simple and somewhat advantageous load division. Obviously the coil currents are the same as the line currents on the open side, and therefore unit A—a will carry only its share of the three-phase load; while unit C—c will bear not only its share of the three-phase load but also all of the single-phase load.

If the delta were closed, the current in A—a would have been 57.7% of the three-phase line current, and its corresponding kva rating would have been  $(\frac{1}{3})$  three-phase load. But as its current is now the same as the line current, its rating will be  $(1/0.577)$  times as much, or  $(\frac{1}{3})(1/0.577) = 57.7\%$  of the load, representing a premium of 15.5% in capacity. This, however, need not be considered exorbitant. The worst that can happen to unit C—c is that the three-phase and one-phase current could happen to be in phase with each other, adding arithmetically, in which case the kva capacity required of C—c would be  $0.577 \times$  the kva of the three-phase load + the kva of the single-phase load.

As the primary neutral (the ground) will now have to carry load currents, such

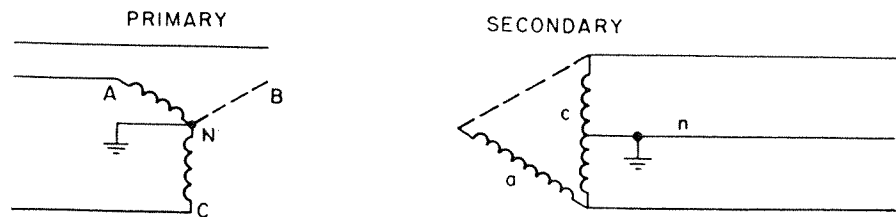

FIGURE 5. Open Y primary with open delta secondary connection

a system is suitable only for very small loads or for four-wire systems.

All dissymmetrical banks tend to unbalance the voltage under load. Figure 5 is an extreme case of dissymmetry.

A rather important fact, not recognized extensively enough, is that three-phase motors are generally sensitive to unbalance in voltage, their current unbalance being 5–10 times as much as the voltage unbalance.

The reason for this is that an unbalanced three-phase voltage amounts to two symmetrical three-phase voltages, the larger set with positive phase rotation, the smaller one with negative phase rotation. To this negative component,

the motor offers, not a generated counter e.m.f., but a leakage impedance only. As this leakage impedance is generally in the range of 10% to 20%, it follows that a given percent negative-rotational component of voltage will cause 10 to 5 times as much percent short-circuit current in the motor. A 6% voltage unbalance may sound as nothing serious, but if it results in at least 30% current unbalance in the three-phase motors, it cannot be ignored so lightly. So, in three-phase systems subject to appreciable voltage unbalance, it would seem to be common sense to measure the unbalance in the currents of some representative three-phase motors and avoid motor burnout from this cause.

## PART VII

### Transient characteristics of transformer windings.

THE transient characteristics of a transformer winding involve two classes of phenomena: distribution of the stresses in the winding, a matter within the control of the designer; and stresses to ground that may appear at the winding terminals including the neutral, a matter considerably within the control of the operator. Although both matters are of vital importance to the safety of a transformer installation, the present discussion may be more profitable to the reader if we devote it to those matters over which he may have a measure of control. The broad field may be more conveniently discussed under two headings; namely, windings on which abnormal voltages are impressed from an external source to which they are connected; and "floating" windings, in which abnormal voltages are induced either magnetically or electrostatically. In the first group we may consider also the transient phenomena that are peculiar to autotransformers.

\*This will be a partially saturable reactance of a moderate power factor because of high losses. "Partially" saturable, because it has an air return in its magnetic circuit.

#### Windings Connected To A Line

Let us first consider the simple transformer, and then the auto-transformer.

The level of the abnormal voltages that can become imposed on the high-voltage line terminals of a winding connected to a transmission line is obviously determined by the line insulation and the lightning arrester, and needs no particular discussion here; but the matter of neutral potentials may call for some comments.

Unless specially designed to the contrary, a winding hit by an impulse wave tends to vibrate electrically somewhat like a piano wire hit by a keyboard hammer. The frequency of the oscillation and the relative amplitudes of the harmonics are determined by the design of the winding (or piano wire). Such phenomena are therefore called *free* or *characteristic* oscillations.

In a free oscillation, there are "loops" and "nodes" as shown in Figure 1. The loop is a point that undergoes the maxi-

mum cyclic change, between maximum positive and maximum negative values; and the node one that remains unchanged. In Figure 1, *a, a* are nodes for vertical motion; *b*, a loop. But if, instead of considering vertical motion, we should consider a vertical force, *a, a* are loops (points of force maxima), and *b* a node. And so it is that when a string breaks while playing, it is apt to do so at a support. Thus a force node is a motion loop, and vice versa. In electrical terms, in a free oscillation, a current node will be a voltage loop, and vice versa, so that where the current is maximum, the voltage will be zero, and vice versa. As there can be no current in an isolated neutral, the voltage to ground at that point will be a maximum. As the potential of the line end is fixed from the external source, the neutral end vibrating freely may assume potentials higher than that impressed at the line end. Both theory and tests indicate that, in an oscillation under an impulse wave, an isolated neutral may acquire a potential as high as two to three times that at the

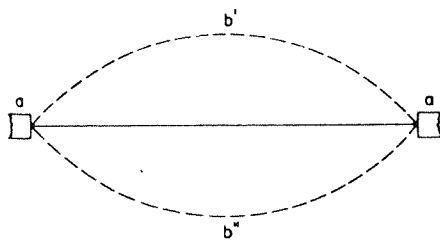

Nodes and loops in a string: a, a are nodes and b is loop for vertical movement; a, a are loops and b is node for vertical force

FIGURE 1. Diagram of winding oscillation

line terminal.<sup>1</sup> Evidently the isolated neutral bushing and the isolated neutral end of the winding may need more insulation strength to ground than does the line bushing and the line end of the winding, *unless* by appropriate design the initial voltage distribution is substantially linearized and the winding is rendered non-oscillating or substantially so. As is well-known, grounding the neutral "solidly" (without impedance) and "permanently" permits substantial reduction in the insulation of the neutral end and a substantial saving in the cost of the transformer.

The foregoing comments apply in a general way to all winding connections, but it may be of some interest to compare the isolated Y-Y connection of single-phase units, Figure 2A with the Y-Delta, Figure 2B, and the Delta-Y, Figure 2C.

As an oscillation involves both inductance and capacitance, the lower the inductance, the higher will be the resulting frequency and damping. Little differences, such as that between a 6 percent and a 12 percent reactance may not be significant, but that between the leakage reactance (of say 10 percent) and the magnetizing reactance (of say 10,000 percent, representing 1 percent exciting current) could be significant. Naturally, the power loss associated with the inductance—or more precisely, the power factor of the inductance—is even more important as the major damping agent for the oscillation. Dielectric losses come in too, but generally they are much smaller than the  $I^2R$  losses and the magnetic losses.

Figure 2 illustrates, in a simplified manner, whether it is the magnetizing reactance or the leakage reactance that enters into the fundamental mode of oscillation of the winding. The capacitances of the primary (high-voltage) windings to ground are shown as massed at the middle of each phase. The line-end half of the winding in series with the

capacitance to ground constitutes an oscillatory circuit. It is assumed here for simplicity that the incoming wave is identical in all three lines. This is often true for induced lightning voltages. A direct stroke may be in only one line, but its analysis is somewhat more complicated. It will be recalled from a previous installment that the symmetrical case—in phase in all three lines—constitutes a zero-phase-sequence set, and will therefore encounter the zero-phase-sequence reactance of the windings.

In Figure 2A no induced secondary (L. V.) currents can flow to neutralize the magnetizing effect of the primary currents, seeing that the secondary neutral is isolated. By virtue of the lowness of the voltage the capacitance currents are negligible. So the windings offer a core-magnetizing reactance to these currents. This high reactance is the zero-sequence reactance of Y-Y connected transformers. But in Figure 2B, the currents induced in the delta-connected windings can circulate within the delta, and so the windings offer only the leakage reactance between the primary and the

secondary windings. This low reactance is the zero-sequence reactance of Y-delta connected units.

As we have seen before, the zero-phase-sequence reactance of three-legged three-phase transformers is intermediate between leakage reactance and magnetizing reactance.

Figure 2C shows a delta high-voltage, Y low-voltage, bank. Each phase of the delta may be said to have a neutral of its own—its mid-point—as it will be noted that in each phase there are two currents flowing from the lines towards the mid-point of that phase. These two currents neutralize each other's magnetizing effect on the core and encounter only the leakage reactance between the two halves of each primary winding. Thus, there is a large difference between the impedances of delta-connected windings and isolated-neutral Y-Y windings with respect to their fundamental modes of oscillation, though both banks are isolated.

Let us consider now some transient phenomena peculiar to autotransformers.

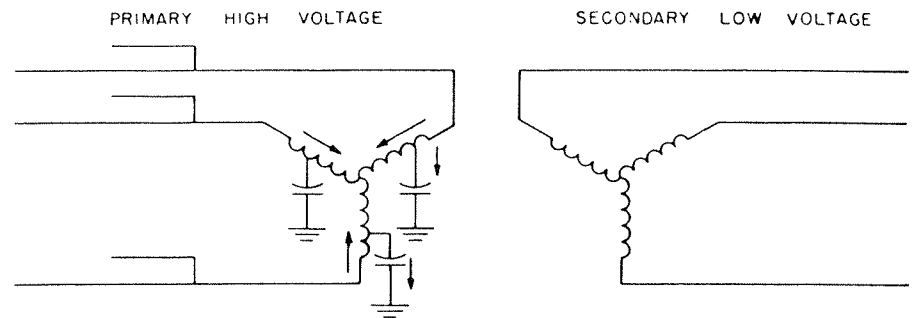

FIGURE 2A. The Y-Y connection of a single-phase unit with the secondary neutral isolated

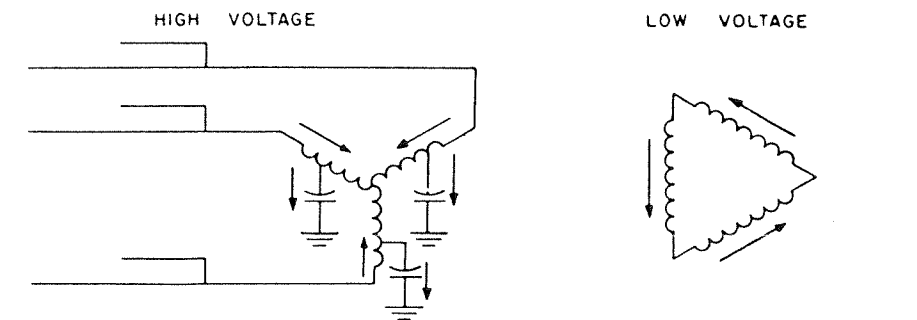

FIGURE 2B. The Y-Delta connected unit showing the induced currents in the delta winding

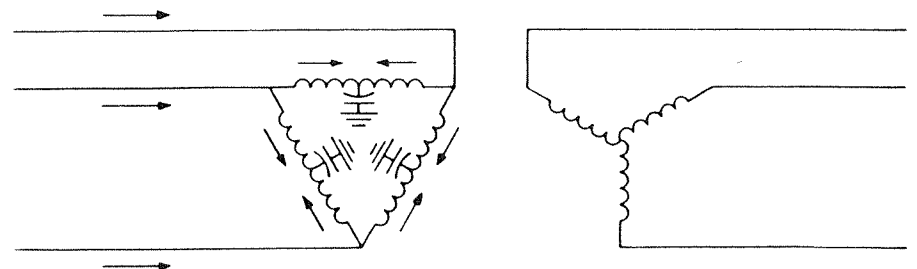

FIGURE 2C. Delta high-voltage, Y low-voltage connection showing neutralization of currents

<sup>1</sup> See the book *Transformer Engineering*, L. F. Blume, Editor, Chap. XVII, Fig. 8, p. 471 and related text.

### Isolated-neutral Y Autotransformer

The series winding (*S*, in Figure 3) of an autotransformer is an inductive series link between the incoming line *A* and the outgoing line *B*. Therefore, there is a strong tendency for an incoming surge to become concentrated across the obstructive impedance of *S*. Comparing Figure 3A (no delta) with 3B (with tertiary delta), the ratio of the two impedances may be seen to be that of a magnetizing reactance to leakage reactance, which may be at least 100:1, leaving little need to resort to advanced mathematics to appraise the relative voltage concentrations, at least qualitatively.<sup>2</sup>

Another important consideration is that in Figure 3A the voltage developed across *S* will be stepped up into *P* approximately by turn ratio, raising the potential of *N* to a dizzy height. In a tap-changing voltage regulator with, say, one percent steps, the ratio of common to series turns on the first step will be 100:1, and so the seriousness of this overvoltage at the neutral may be appreciated. In Figure 3B (with a tertiary delta), not only the voltage across *S* will be a small fraction of that in 3A, but in general only a fraction of the reduced voltage across *S* may be induced in *P*, due to the magnetic shielding action of the induced circulating current in the delta.

As any series inductive device, even one of a reasonably low 60-cycle reactance, is likely to develop considerable voltage when subjected to a 10,000–50,000 ampere surge current wave, *it is generally wise to protect the series windings of autotransformers with thyrite resistances*. This is particularly desirable in step voltage regulators in which, not only the insulation safety of the winding parts must be considered, but that of the ratio adjuster equipment connected to the taps is also important.

<sup>2</sup>The capacitance of the outgoing line also has to be taken into account for a quantitative result.

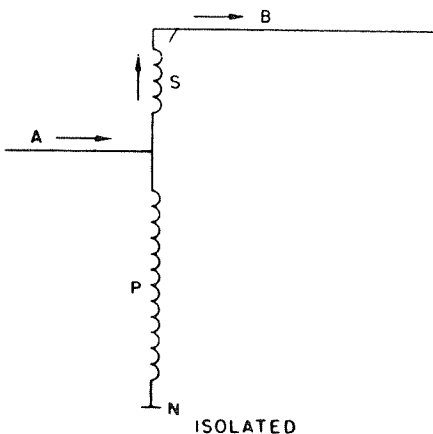

FIGURE 3A. Y-Autotransformer without delta

### Grounded-neutral Autotransformer

We have seen in the earlier issues that, in a grounded system, the grounded-neutral autotransformer is a highly satisfactory scheme of operation, especially if there is also a delta winding in the bank. While a solidly grounded neutral is safe regardless of any series-winding reactance considerations, it may be seen in Figure 4 that, because currents can now flow freely in the neutral, the reactance of the series winding to surges will be very low: in the absence of a delta, it will be only the leakage reactance between *S* and *P*, a low figure; and in the presence of a delta, still less. In this case, the delta is not essential for surge considerations, but it will keep the harmonic currents out of the neutral; and, of course, it is also a backup protection in case the circuit between the two neutrals should become temporarily opened, as by line breakers opening on one side.

Another precautionary comment that may be made here is that, as delta windings in autotransformers are generally designed for 35 percent of the physical capacity of the series or common windings, it is wise to make certain that, under the most unfavorable system fault condition, the delta winding is not overloaded.

### Floating Windings<sup>3</sup>

A "floating" winding is a winding which is isolated from ground and all external circuits of appreciable capacitance. The electrostatic potential of such a winding is determined by the capacitance distribution of the transformer, and under certain conditions indicated below, such a winding may be subjected to high potentials to ground by electrostatic induction from the high-voltage winding.

A floating high-voltage winding may also be subjected to high voltages by electromagnetic induction from the low-

<sup>3</sup>This section taken from publication GET-2382 of the General Electric Company.

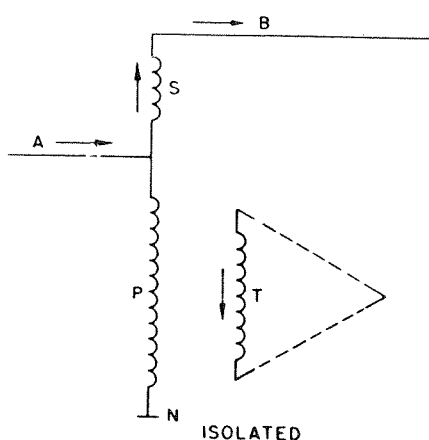

FIGURE 3B. Y-Autotransformer with the delta

voltage winding.

The fact that the major insulation of a floating winding may be safe in a given case does not guarantee the safety of the bushing and connected idle bus bars or other equipment of low capacitance to ground. Therefore, it is advisable to take precautions to prevent over-voltages and resulting sparking from such parts to ground. The general nature of these troublesome conditions and the recommended methods of protection are as follows.

### Electrostatic Induction

Electrostatic induction is hazardous when the isolated winding is at a much lower voltage rating than the inducing winding, because this type of induction is determined not by turn ratio but by the relative distribution of the capacitances among the windings and ground. Generally the capacitance distribution leads to much higher potentials in the low-voltage windings than turn ratio would have done.

In a single single-phase transformer installation, with the high-voltage terminals connected to two lines of a three-phase system, the high-voltage winding normally has an a-c potential to ground (averaged along the winding) approximately equal to one half of the line-to-ground potential. This will tend to induce in a floating low-voltage winding a corresponding electrostatic potential based on the capacitance network of the windings and ground. Likewise, high transient potentials on the lines, that raise the average potential of the high-voltage winding, will induce high potentials in a floating low-voltage winding, possibly intensified by internal oscillations. To illustrate: in commercial impulse testing of high-voltage windings, if the low-voltage windings were allowed to float, the low-voltage bushings would flash over to ground in most cases. Therefore, it is standard practice to connect the low-voltage bushings to ground through a resistance during that test.

In symmetrical three-phase installations, the vectorial average of the normal frequency potentials of the three phases to ground is zero, and therefore the corresponding average normal-frequency potential to ground of a symmetrical three-phase floating winding also will be zero. As the electrostatically induced potentials in the three secondary phases tend to neutralize each other by an exchange of small capacitance currents, and at the operating frequencies the windings offer negligible impedance to the flow of these currents, the maximum *local* values of the electrostatically induced *normal-frequency* potentials will be negligible. However, if for any reason the neutral of the high-voltage winding should shift, or



the potential of the high-voltage windings should be raised as a whole, a corresponding electrostatic potential will be induced in a floating winding on the transformers. This is likely to occur under the following conditions.

### 1. Lightning

Lightning on the high-voltage lines is the source of maximum electrostatic induction from the high-voltage windings to a floating low-voltage winding. Due to the steepness of these potentials, some portions of a floating winding may be raised to much higher potentials than the average of that winding. The worst case for electrostatic induction to a floating winding is when lightning raises the potentials of all three high-voltage lines equally.

### 2. Switching with Single-pole Switches or Blowing of Fuses

In switching with single-pole air-break switches, or in the blowing of two fuses, one line may be closed and the other two open for an appreciable length of time during which the entire high-voltage winding is raised to the potential of the closed line inducing an abnormal potential in a floating low-voltage winding. These voltages are less than those in case (1) but are of relatively long duration.

### 3. Switching by Oil Circuit Breaker

As the three contacts of an oil circuit breaker cannot be expected to open or close exactly simultaneously, their operation also leads to the same situation as in (2) but with very much shortened duration.

### 4. Line-to-ground Fault on Isolated Three-phase System

A line-to-ground fault on an isolated three-phase system shifts the neutral and average potential of the high-voltage windings and induces a corresponding abnormal electrostatic potential in a floating winding.

### 5. Dynamic Overvoltages

Unbalanced fault conditions, even in a grounded-neutral system, may cause neutral shift of the high-voltage windings and electrostatically induce a corresponding abnormal potential in a floating winding.

### 6. Other Cases

Accumulation of electrostatic charges and other obscure causes may lead to abnormal potentials in floating windings.

## Electromagnetic Induction

While electrostatic induction can produce dangerous voltages when the floating winding is of a much lower voltage rating than the inducing winding, electromagnetic induction may produce dangerous voltages when the floating winding is of much higher voltage rating than the

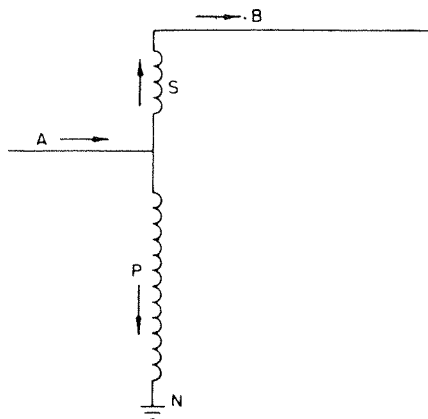

FIGURE 4A. Grounded-neutral autotransformer

inducing winding. An impulse voltage concentrated across a low-voltage winding or portion thereof may be stepped up roughly by turn ratio in a floating high-voltage winding; and if the factor of safety of the low-voltage winding for its own voltage classification is much higher than that of the floating high-voltage winding for its classification, then the hazard will be greater in the high-voltage winding. Furthermore, the stress in the high-voltage winding may also become complicated and intensified by the oscillation occasioned by a steep-front induced voltage.

## Recommendations

When equipment is exposed to dangerous overvoltages, it is generally customary to provide suitable protection in the form of lightning arresters for the unit. If the conditions discussed above apply to a floating winding, provision for its protection may be advisable depending on its connection.

### 1. Windings in Y Connection

(a) Directly ground the neutral and provide lightning arresters on the three line terminals. Low-frequency electrostatic induction will be taken care of by the grounding of the neutral alone, but induction due to impulses or switching surges makes arresters on the line terminals advisable.

(b) When for some reason the neutral may not be directly grounded, connect a lightning arrester between the neutral and ground, in addition to the arresters on the line terminals.

### 2. Windings in Delta Connection

(a) Ground one terminal of the delta, and connect lightning arresters between each one of the other two terminals and ground.

(b) If the grounding of one terminal of the delta is objectionable because of large fault currents, the grounding may be made through an appropriate resistance to limit these currents to the desired

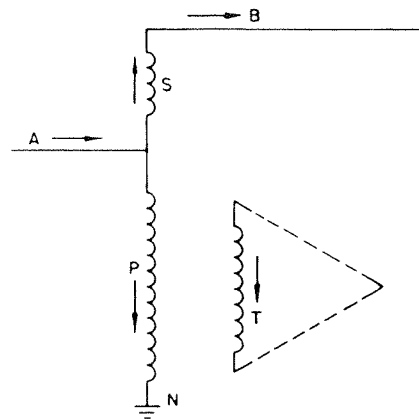

FIGURE 4B. Grounded-neutral with the delta

value. In this case a lightning arrester should be connected between that terminal and ground, the same as for the ungrounded terminals.

(c) In systems with protective relays responsive to electrostatic unbalancing of the lines, the grounding of a terminal of the delta, even through a resistance, may be objectionable. In such cases grounding may be omitted and an arrester connected between each delta terminal and ground.

A practical difference between this case (c) and cases (a) and (b) is that in cases (a) and (b) the occasions for the arresters to discharge will be greatly reduced.

### 3. Selection of Arresters

In selecting arresters for application between the line end of floating windings and ground, an arrester rating must be chosen which exceeds the *maximum power frequency voltage* which can be impressed across the arrester in case one of the terminals is either temporarily or permanently grounded.

This voltage is a function of the connected system parameters, as well as the transformer characteristics; and, therefore, each application must be individually examined. General guidelines, however, indicate:

1. For delta-connected or wye-connected, ungrounded windings, the arresters are generally in the order of 100% of maximum line-to-line operating voltage.
2. If the winding is wye-connected and the neutral solidly grounded, the arresters may be in the range of 72% to 80% of maximum line-to-line system operating voltage.
3. If the winding is wye-connected and a neutral arrester is used, the arrester rating may be approximately 70% of maximum line-to-line system operating voltage.

It should be stressed that specific system conditions and parameters may require arrester ratings in excess of those indicated.

# PART VIII

## Calculation of neutral shift of isolated-neutral autotransformers

**B**EFORE an autotransformer is operated with neutral isolated, the neutral shift, during ground faults on the system, should be thoroughly investigated to make certain that the autotransformer neutral insulation and neutral lightning arrester, if one is used, will not be subjected to excessive power-frequency voltages. This section deals with methods of calculating neutral shift.

As there are likely to be a number of "neutrals" in a polyphase system, it might be worthwhile to clarify them first.

Figure 1 shows a power source, S, in Y connection with its neutral point,  $N_S$ , grounded through an impedance  $Z_N$ . One neutral is  $N_S$ ; another is ground, G, whose potential is a logical reference potential as "neutral" or zero potential at all times. An autotransformer, T, is shown with its own neutral point,  $N_T$ , which may be at still another potential. Then there is such a thing as the "neutral" of the lines (not shown in Fig. 1) representing the center of gravity of the line potentials and normally coinciding with G. The potential of this neutral is not necessarily zero with respect to ground under all conditions. It can be identified as follows: Connect three duplicate resistors (or impedances) in isolated Y across the lines. The potential of the neutral of this bank will be the center of gravity of the line potentials, and it may be called the "neutral of the lines." The suggested bank of impedances to identify this neutral may be capacitors, in which case the capacitance elements may be the capacitances of the lines themselves. If the capacitances are not perfectly symmetrical, the "neutral" which

they identify will be different from that which a symmetrical impedance bank would identify. In such a case, the neutral of the lines will have two different meanings. Moreover, the neutral of the lines may be different at different points of the system, such as on the primary and secondary sides of a transformer.

Let us calculate the potentials of some of these "neutrals" when one of the lines is faulted to ground. The method of symmetrical components is so convenient for such problems that we cannot refrain from using it.

### Case 1. Source Grounded through an Impedance, Autotransformer Isolated, Stepping Down, Fault on Primary (HV) Line.

Figure 1 shows the diagram of connections with a fault to ground on line A between the source and the autotransformer. Figure 2 shows the positive-, negative-, and zero-sequence equivalent networks interconnected to represent the assumed fault condition. The various quantities shown in Fig. 2 are defined as follows:

$Z_{1S}$ ,  $Z_{2S}$  and  $Z_{0S}$  are respectively the per-unit positive-, negative-, and zero-sequence impedances of the source S.

$Z_{0N}$  is the per-unit zero-sequence impedance of the neutral impedance. It is obtained by taking the ratio of  $3 Z_N$  (ohms) to the base impedance (ohms) at the terminals of the source.

$Z_{1T}$  is the per-unit positive-sequence impedance of the autotransformer, T.

$Z_{0H}$ ,  $Z_{0L}$  and  $Z_{00}$  are the per-unit branch impedances of the 3-terminal zero-sequence equivalent circuit which represents

the zero-sequence impedance characteristics of the autotransformer with neutral grounded. The ideal autotransformer, R, shown in the zero-sequence equivalent network takes care of neutral isolation\*.

All per unit impedances are based on rated line-to-neutral voltages and the same kva.

R is an ideal autotransformer, the ratio of transformation of which is exactly the same as that of the actual autotransformer being represented. It should be noted that the low-voltage side of the ideal autotransformer is connected to the H-side of the equivalent network and the high-voltage side of the ideal autotransformer is connected to the L-side of the equivalent network. This might seem to be opposite to what it should be, but it is correct.

$E_{NS}$  is the per unit neutral shift of the source neutral,  $N_S$ . It is based on rated line-to-neutral voltage at the terminals of the source.

$E_{NH}$  is the per unit neutral shift of the high-voltage lines. It is based on rated line-to-neutral voltage of lines A, B and C.

$E_{NT}$  is the per unit neutral shift of the autotransformer neutral,  $N_T$ . It is based on the rated line-to-neutral voltage at the high-voltage terminals of the autotransformer.

$E_{NL}$  is the per unit neutral shift of the low-voltage lines. It is based on the rated line-to-neutral voltage of lines a, b and c.

All of the neutral shifts are with respect to ground potential.

\* Refer to "A Zero-Sequence Equivalent Circuit of Autotransformer Connections which Yields Neutral Shift," B. A. Cogbill, AIEE Transactions, 1956, Part 111, pp 1228-32.

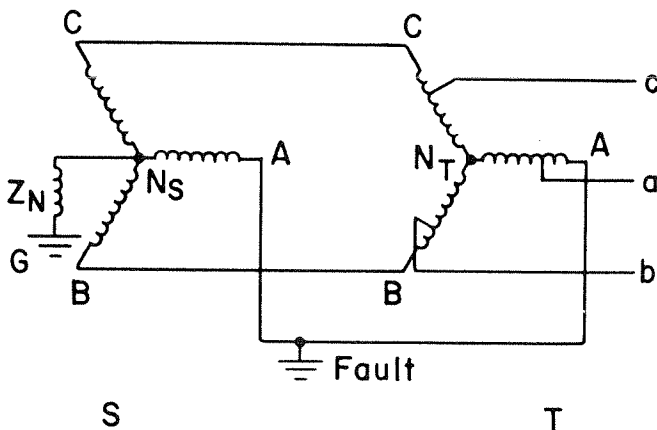

FIGURE 1. Source grounded through an impedance, autotransformer neutral isolated, fault on source side of autotransformer.

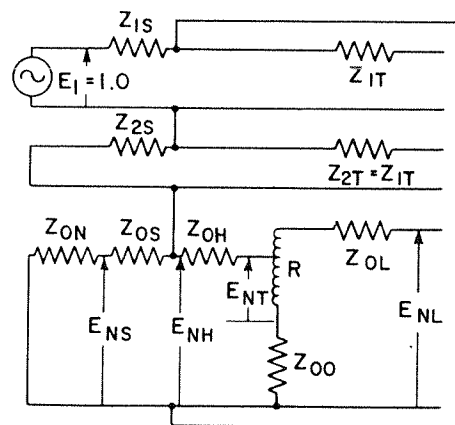

FIGURE 2. Positive-, negative-, and zero-sequence networks interconnected to represent fault on source side of autotransformer.

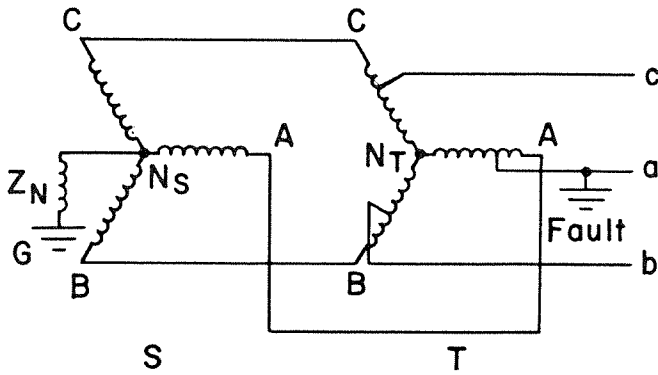

FIGURE 3. Source grounded through an impedance, autotransformer neutral isolated, fault on secondary side of autotransformer.

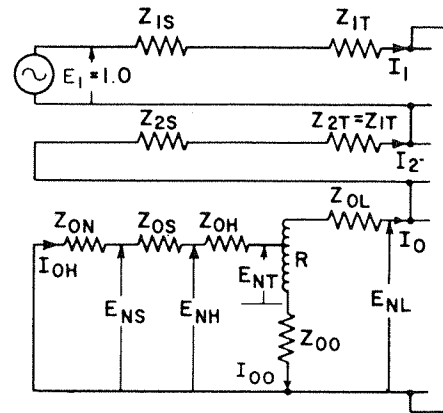

FIGURE 4. Positive-, negative- and zero-sequence networks interconnect to represent fault on secondary side of autotransformer.

With rated positive-sequence source voltage applied, it is obvious from the interconnected equivalent networks of Fig. 2, that

$$E_{NS} = \frac{Z_{0N}}{Z_{1S} + Z_{2S} + Z_{0S} + Z_{0N}} \quad (1)$$

and

$$E_{NH} = E_{NT} = \frac{Z_{0N} + Z_{0S}}{Z_{1S} + Z_{2S} + Z_{0S} + Z_{0N}} \quad (2)$$

$$E_{NL} = r E_{NH} \quad (3)$$

where  $r = \frac{E_H \text{ Base}}{E_L \text{ Base}}$  = ratio of transformation of ideal autotransformer

Thus we have simple formulas for calculating the shifts of the four "neutrals" under the specified fault condition. It should be noted that under this condition there is no fault current in the autotransformer.

The autotransformer neutral,  $N_T$ , has shifted with respect to ground, but not with respect to the line potentials. The source neutral has shifted with respect to both the ground and the lines.

Because there is no fault current in the autotransformer, the values of  $Z_{0H}$ ,  $Z_{0L}$ , and  $Z_{00}$  do not affect the results. Hence, under the assumed fault condition the presence or absence of a delta-connected winding does not affect the shift of the autotransformer neutral.

Step-up or step-down connection of the autotransformer also is immaterial to the value of the neutral shift with respect to the primary lines, but a given neutral shift may be very differently appraised from the standpoint of the safety on the low-voltage system. To illustrate this, let the neutral shift given by equation (2) be 0.50 (of the high-voltage line-to-neutral voltage). Let the low-voltage rating of the autotransformer be one tenth of that of

the high voltage. As the high- and low-voltage neutrals of the autotransformer are one and the same point, the 50% shift of this neutral in terms of the high-side voltage will be ten times as much, or 500% shift, for the low-voltage system.

This is an accentuated illustration of the reason for the maxim that a proposal for the use of an isolated-neutral autotransformer with more than 2:1 ratio should be carefully scrutinized, because with increase in this ratio the economy of the autotransformer over the conventional transformer gets smaller and such troubles greater.

### Case II. Same As Case I Except Fault On Secondary Side of Autotransformer.

The connections for this case are shown in Fig. 3; and the positive-, negative-, and zero-sequence networks interconnected to represent the assumed fault condition are shown in Fig. 4. For this case no simple expressions such as equations (1), (2) and (3) are obtainable because the circuit of Fig. 4 is more complicated than that of Fig. 2. Therefore, a numerical example will be used to illustrate the method of calculation.

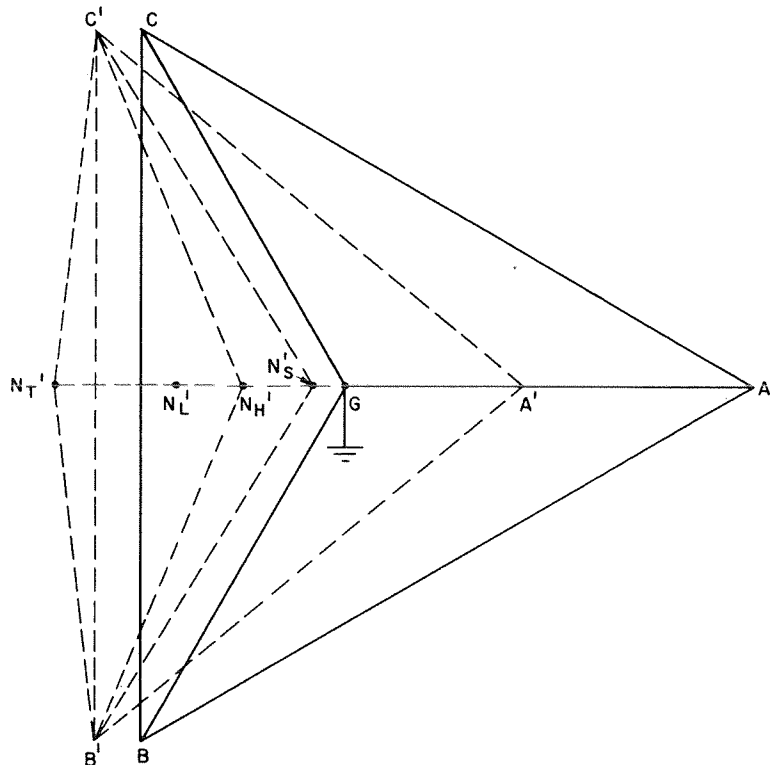

FIGURE 5. Phasor diagram showing relative potentials of source lines and various "neutrals" before fault and while fault is on secondary side.

Assume the following per unit values of impedances based on 50,000 Kva:

$$Z_{1S} = Z_{2S} = Z_{0S} = j 0.0250$$

$$Z_{0N} = j 0.0100$$

$$Z_{1T} = j 0.0167$$

$$Z_{0H} = j 0.0100$$

$$Z_{0L} = j 0.0034$$

$$Z_{00} = j 0.3166$$

The autotransformer is rated 50,000 Kva, 138 to 115 Kv and has a delta-connected stabilizing winding. The ideal autotransformer shown in the zero-sequence equivalent network has the same ratio of transformation as the actual autotransformer being represented, that is  $r = 138$  to  $115 = 1.2$  to 1.

The impedance of the zero-sequence equivalent network can be found to be  $Z_0 = j 0.0809$

The total impedance of the interconnected networks is

$$Z = 2 (j 0.0250 + j 0.0167) + j 0.0809 = j 0.1643$$

Therefore, the positive-, negative-, and zero-sequence components of fault current are

$$I_1 = I_2 = I_0 = \frac{1.000}{j 0.1643} = -j 6.08 \text{ per unit.}$$

Since  $I_0$  is  $(-j 6.08)$  the ideal autotransformer forces  $I_{0H}$  to be

$$I_{0H} = 1.2 (-j 6.08) = -j 7.296 \text{ per unit.}$$

Similarly

$$I_{00} = 0.2 (-j 6.08) = -j 1.216 \text{ per unit.}$$

Using these per unit currents, through the per unit impedances, the various neutral shifts are found to be

$$E_{NS} = -(j 0.0100) (-j 7.296) = -0.07296$$

$$E_{NH} = -(j 0.0350) (-j 7.296) = -0.2554$$

$$E_{NT} = -(j 0.0450) (-j 7.296) - (-j 1.216) (j 0.3166) = -0.7133$$

$$E_{NL} = -(j 0.0809) (-j 6.08) = -0.4919$$

Converting these per unit quantities to voltages

$$E_{NS} = -0.07296 \times 138 / \sqrt{3} = -5.81 \text{ Kv}$$

$$E_{NH} = -0.2554 \times 138 / \sqrt{3} = -20.35 \text{ Kv}$$

$$E_{NT} = -0.7133 \times 138 / \sqrt{3} = -56.80 \text{ Kv}$$

$$E_{NL} = -0.4919 \times 115 / \sqrt{3} = -32.60 \text{ Kv}$$

The phasor diagram showing the potentials of the various "neutrals" with respect to ground is shown in Fig. 5. The solid lines and unprimed symbols are for unfaulted conditions; dash lines and primed symbols are for the fault condition. Before the fault occurs all "neutrals" are at the potential of ground, G.

If the delta-connected stabilizing winding had been omitted from the autotransformer, the values of autotransformer equivalent circuit impedances (assuming 3-leg core-type construction) would change to something in the order of:

$$Z_{0H} = -j 0.0913$$

$$Z_{0L} = j 0.1080$$

$$Z_{00} = j 3.5880$$

Using these values, the shift of the autotransformer neutral is calculated to be 204 kv with respect to ground, which is approximately 1.5 times the rated line-to-line voltage on the high-voltage side. The other neutral shifts are also different from the corresponding figures calculated for the autotransformer with delta-connected stabilizing winding.

POWER TRANSFORMER DEPARTMENT

GENERAL  ELECTRIC

PITTSFIELD, MASS.